

eduard  
MASK

# AH-64D Apache 1/48

The die-cut mask for accurate canopy frame painting of the  
*Hasegawa* 1/48 KIT

EX 022

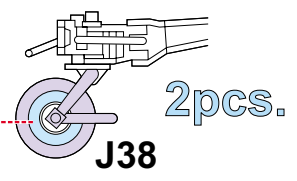
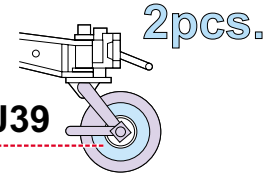
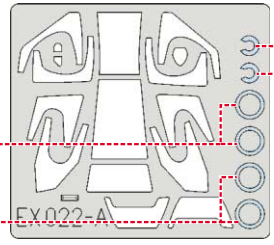
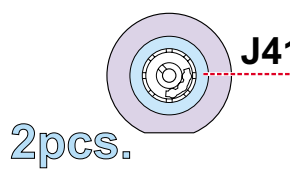
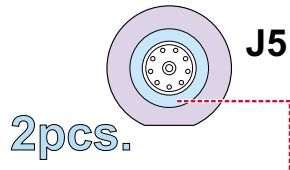
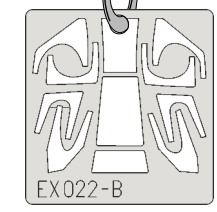
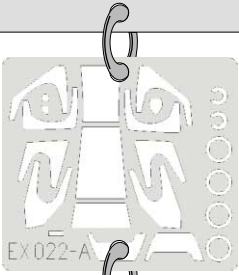

LIQUID MASK

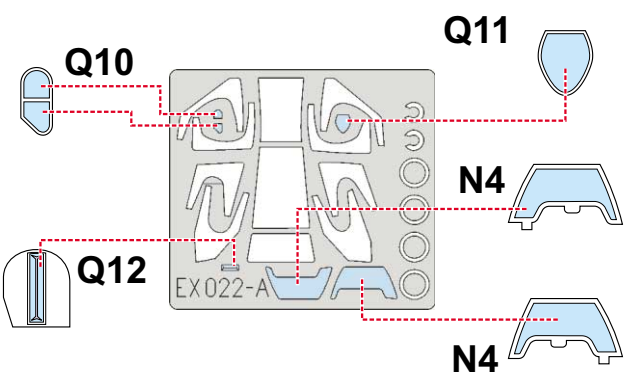

LIQUID MASK

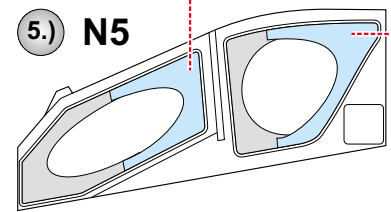
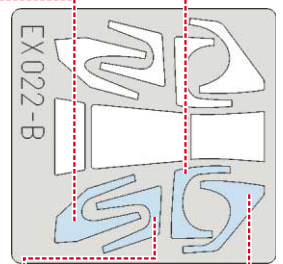
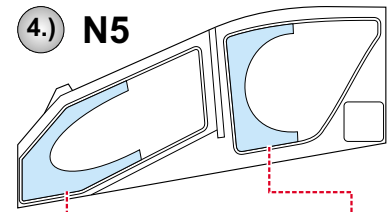
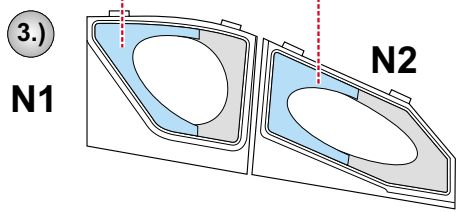
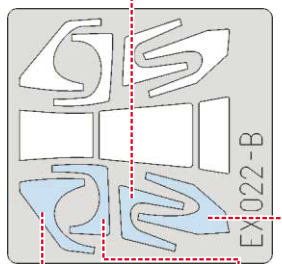
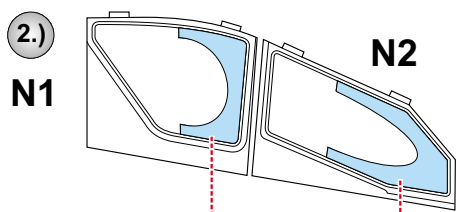
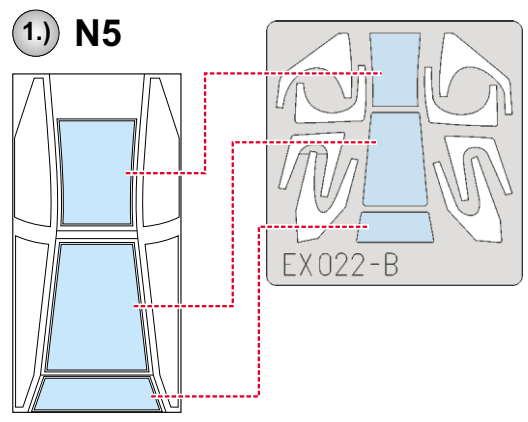

6.)  INTERIOR COLOR

7.)  RUBBER COLOR

8.) REMOVE MASK

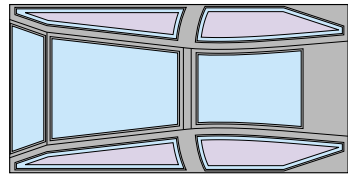

 - LIQUID MASK

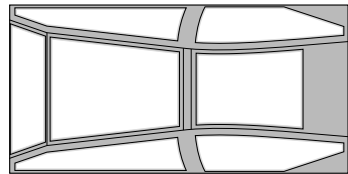

9.) N5

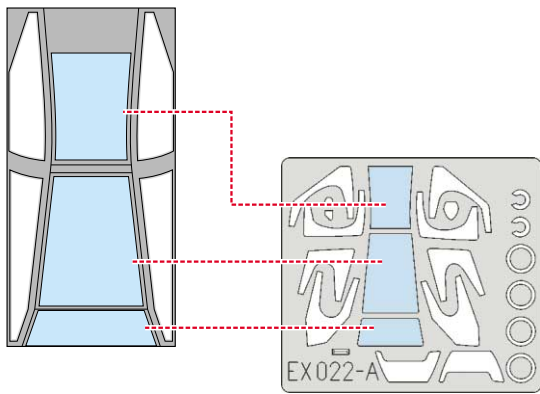

10.)

N1

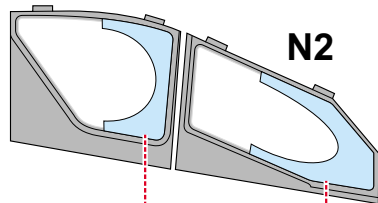

N2

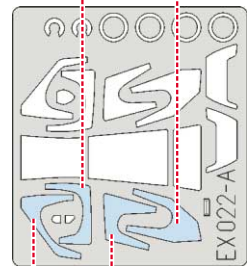

12.) N5

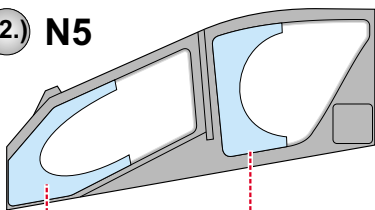

11.)

N1

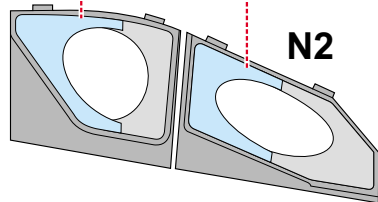

N2

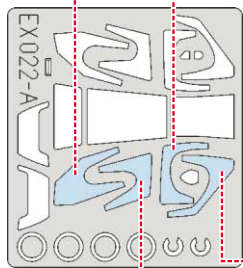

13.) N5

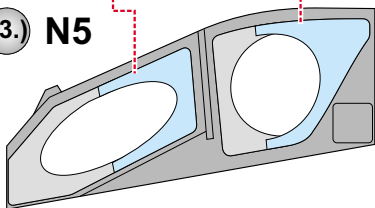

14.) 

CAMOUFLAGE COLOR

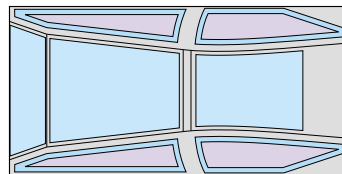

 - LIQUID MASK